

# Grove GMK6300L

## North American Product Guide

ASME B30.5  
Imperial 85%

### Features

- (300 t) 350 USt capacity
- 15,6 m - 80 m (51 ft - 263 ft) seven-section full power MEGAFORM™ boom with TWIN-LOCK™ pinning
- 12 m - 21 m (39 ft - 69 ft) hydraulic offset bi-fold swingaway
- 2 x 8 m (26 ft) intermediate lattice inserts
- 92,5 t (203,900 lb) counterweight with hydraulic removal system
- MEGATRAK™ independent hydro-pneumatic suspension
- Allison 4500 SP transmission



# Features

## MEGATRAK™

The MEGATRAK™ suspension system is the best off road driveline available on the market today. The system's versatility and performance allows the GMK6300L to operate as a true all-terrain crane. The MEGATRAK™ independent suspension and all-wheel steer system allows wheels to remain on the ground at all times so stresses and weight are not continually transferred between axles. MEGATRAK™ provides true ground clearance where others just raise the chassis.

Other benefits of the MEGATRAK™ system are:

- A reliable suspension system
- Excellent job site maneuverability with all-wheel steering
- Commonality among almost all models
- A driveline that remains aligned at all times
- A steering linkage system that is protected against damage
- Constant tire contact for equal tire wear
- Reduced maintenance



## TWIN-LOCK™

Boom pinning mechanism automatically pins the sections in position using two horizontal pins.



## CraneSTAR

CraneSTAR is an exclusive and innovative crane asset management system that helps improve your profitability and reduce costs by remotely monitoring critical crane data. Visit [www.cranestar.com](http://www.cranestar.com) for more information.

## ECOS

Electronic Crane Operating System - ECOS enables control of the entire crane's principle operations. Simple programming eases lift planning and a supply of essential information allows full concentration on the lift itself.



## EKS 5

The EKS 5 monitors the lifting conditions of the crane at all times and provides a full graphic display, rear lighting, graphic of boom telescoping percentage, and load charts.



# Contents

Specifications	4
Dimensions	7
Weights	8
Counterweight	9
Working range (main boom)	10
Load charts (main boom)	11
Working range (Offsettable swingaway)	16
Load charts (Offsettable swingaway)	17
Working range (Offsettable swingaway with inserts)	19
Load charts (Offsettable swingaway with inserts)	20
Working range (Heavy duty jib)	22
Load charts (Heavy duty jib)	23
Symbols glossary	25

# Specifications

## Superstructure



### Boom

15,6 m - 80 m (51 ft - 263 ft) seven-section, full power MEGAFORM™ boom with TWIN-LOCK™ pinning. Maximum tip height: 83 m (272 ft).



### Boom nose

Nine nylatron sheaves, mounted on heavy duty tapered roller bearings with removable pin-type rope guards. Quick reeve boom nose. Removable auxiliary boom nose with removable pin type rope guard.



### Boom elevation

Single lift cylinder with safety valve provides boom angle from -1.5° to +83°.



### \*Hydraulic offsettable lattice extension

12 m - 21 m (39 ft - 69 ft) bi-fold lattice swingaway extension, hydraulically offsettable and luffing under load, 5°- 40°. Maximum tip height: 104 m (341 ft)



### \*Lattice inserts

2 x 8 m (26 ft) inserts for use with lattice swingaway extension to increase length to 37 m (121 ft). Maximum tip height: 120 m (393 ft)



### Load moment and anti-two block system

Load moment and anti-two block system with audio/visual warning and control lever lockout provides electronic display of boom angle, length, radius, tip height, relative load moment, maximum permissible load, load indication and warning of impending two-block condition.



### Cab

All aluminum constructed cab with acoustical lining, hydraulic tilted to 20°. Includes tinted safety glass, adjustable operator's seat, opening windows at side and rear, hinged windshield with wiper, sun visor and window shade. Other features include hot water heater/defroster, armrest integrated crane controls, ergonomically arranged instrumentation and radio/CD player.



### Swing

3 planetary gear boxes with fixed displacement axial piston motors. Infinitely variable to 1.3 rpm. Free swing or hydrostatically engaged brake controlled by swing lever. Swing brake selected by foot operated switch.



### Counterweight

92,5 t (203,900 lb) consisting of various sections with hydraulic installation/removal system controlled from the superstructure cab.



### Engine

Mercedes OM 926 LA six-cylinder

Horsepower: 210 kW (286 bhp) at 2200 rpm

Torque: 1120 Nm (826 ft/lb) at 1400 rpm

Engine emissions: EPA/CARB/EUROMOT Tier IVi (non-road)



### Fuel tank capacity

300 L (79 gal)



### Electrical system

3 phase alternator: 28V/80A

2 batteries: 12V/170Ah



### Hydraulic system

2 (two) separate circuits, 1 (one) axial piston variable displacement pump (load sensing) with electronic power limiting control for crane functions and 1 (one) double gear pump for slewing. Thermostatically controlled oil coolers keep oil at optimum operating temperature.

Hydraulic tank capacity: 1200 L (317 gal)

# Specifications

## Superstructure continued



### Hoist

Main and auxiliary hoist are powered by axial piston motor with planetary gear and brake. "Thumb-thumper" hoist drum rotation indicator alerts operator of hoist movement.

	Main	Auxiliary
Rope length:	350 m (1148 ft)	350 m (1148 ft)
Rope diameter:	22 mm	22 mm
Line speed:	127 m/min (417 fpm)	127 m/min (417 fpm)
Line pull:	93.5 kN (21,020 lb)	93.5 kN (21,020 lb)

Hoist camera and light included.

### \*Optional hook blocks

Lifting capacity	Sheaves	Weight	Parts of line	Possible load with the crane
200 t (220 USt)	9	2400 kg (5291 lb)	2-16	179 t/190 t* (197 USt/209 USt*)
160 t (176 USt)	7	1750 kg (3858 lb)	2-15	135 t (182 USt)
125 t (138 USt)	5	1650 kg (3638 lb)	2-11	100 t (110 USt)
80 t (88 USt)	3	950 kg (2094 lb)	1-7	65 t (72 USt)
32 t** (35 USt)	1	600 kg (1323 lb)	1-3	28 t (31 USt)
12 t*** (13.2 USt)	H/B	300 kg (661 lb)	1	9,5 t (10.5 USt)

\* Requires additional boom nose sheave

\*\* Required for overhaul of single part line with boom/jib lengths in excess of 80 m (262.5 ft)

\*\*\* Overhaul weight designed for a maximum of 80 m (262.5 ft) boom/jib lengths

### \*Optional equipment

- ▶ Work lights, mounted on boom base section
- ▶ Boom mounted aircraft warning light
- ▶ Air conditioning
- ▶ Hook blocks/headache ball
- ▶ Engine independent diesel cab heater, with engine pre-heater. Includes 24 hour timer.
- ▶ Data logger
- ▶ 360° NYC swing lock
- ▶ 2 m (6.6 ft) side stowed heavy duty jib with 38 t (84,000 lb) maximum capacity using four parts of line, offset 8° and 30°
- ▶ Camera system for boom head

## Carrier



### Chassis

Box type, torsion resistant frame is fabricated from high strength steel.



### Outrigger system

Four hydraulic two stage outrigger beams with vertical cylinders and outrigger pads, 700 mm (27.6 in) round. Outrigger can be set in 5 positions:

Full:	8,5 m (27.9 ft)
Partial:	7,4 m (24.3 ft)
Partial:	6,3 m (20.7 ft)
Partial:	5,0 m (16.4 ft)
Retracted:	2,7 m (8.9 ft)

Independent horizontal and vertical movement controlled from each side of carrier and the superstructure cab. Electronic crane level indicators. Hydraulic disconnect for all outrigger beams. Work light for each outrigger beam and outrigger pad load indicator with read out on both sides of carrier and in superstructure cabin. Includes outrigger monitoring system.



### Transmission

Allison automatic 4500 SP, 6 speeds forward, 1 reverse  
2 speed transfer case



### Drive/steer

12x6x12



# Specifications

## Carrier continued

### Axles

1st axle line – drive/steer  
2nd axle line – steer  
3rd axle line – steer (connects for all wheel steer)  
4th axle line – drive/steer (connects for all wheel steer)  
5th axle line – drive/steer (permanent drive with 12x6, disconnects for highway with 12x8)  
6th axle line – steer (optional drive)  
Drive axles with planetary hub reduction and center mounted gearing. Standard inter-axle and cross axle differential locks.

### Suspension

Grove exclusive MEGATRAK™ suspension. Independent hydro-pneumatic system acting on all wheels with hydraulic lockout. Suspension can be raised 170 mm (6.7 in) or lowered 126 mm (5.0 in), both longitudinally and transversely. Features an automatic leveling system for highway travel.

### Tires

12 tires, 445/95 R25 (16.00 R25)  
(vehicle width – 3,00 m [9.8 ft])

### Steering

Dual circuit, hydraulic power assisted steering system. Transfer case mounted, ground driven emergency steering pump. Axles 1, 2, 5 and 6 steer on highway. Separate steering (steer by wire) of the 3rd to 6th axles for all wheel and crab steering, controlled by an electronic rocker switch.

### Engine

Mercedes-Benz OM 502 LA, eight-cylinder  
Horsepower: 405 kW (551 bhp) at 1800 rpm  
Torque: 2600 Nm (1918 ft/lb) at 1300 rpm  
Engine emissions: EPA /CARB/EUROMOT Tier IVi (non-road)

### Fuel tank capacity

500 L (132 gal). Installed on superstructure.

### Brakes

Service brakes: pneumatic dual circuit acting on all wheels.  
Parking brake: pneumatically operated spring loaded brake acting on axle lines 2, 4, 5 and 6.  
Air dryer.

### Cab

Two-man, composite designed aluminum and fiber reinforced plastic construction with the following features: safety glass, driver seat with pneumatic suspension, engine-dependent hot water heater, power windows, heated rear view mirrors, complete instrumentation, driving controls, reversing camera system, air conditioning, radio/CD player, 12V plug and fire extinguisher.

### Electrical system

24V system with three phase alternator, 28V/100A  
2 batteries, 12V/170 Ah

### Maximum speed

85 km/h (53 mph)

### Gradeability (theoretical)

49% - 14.00 tires  
43% - 16.00/20.5 tires

### Miscellaneous standard equipment

Work lights, tool kit, fire extinguishers; auxiliary boom nose and wind speed indicator.

### \*Optional equipment

- 385/95 R 25 tires (14.00 R25)  
(vehicle width – 3,00 m [9.8 ft])
- 525/80 R25 tires (20.5 R25)  
(vehicle width – 3,10 m [10.2 ft])
- 12x8x12 drive/steer; (1, 4, 5 and 6 driven)
- Transmission retarder
- Engine independent diesel cab heater, with engine pre-heater. Includes 24 hour timer.
- Spare tire and wheel with carry bracket
- Rear mounted stowage box
- Trailer hitch
- Optional engine: Tier III Mercedes-Benz OM 502 LA, 420 kW (571 hp) at 1800 rpm. Max. torque: 2200 Nm at 1080 rpm (non-road)

# Dimensions

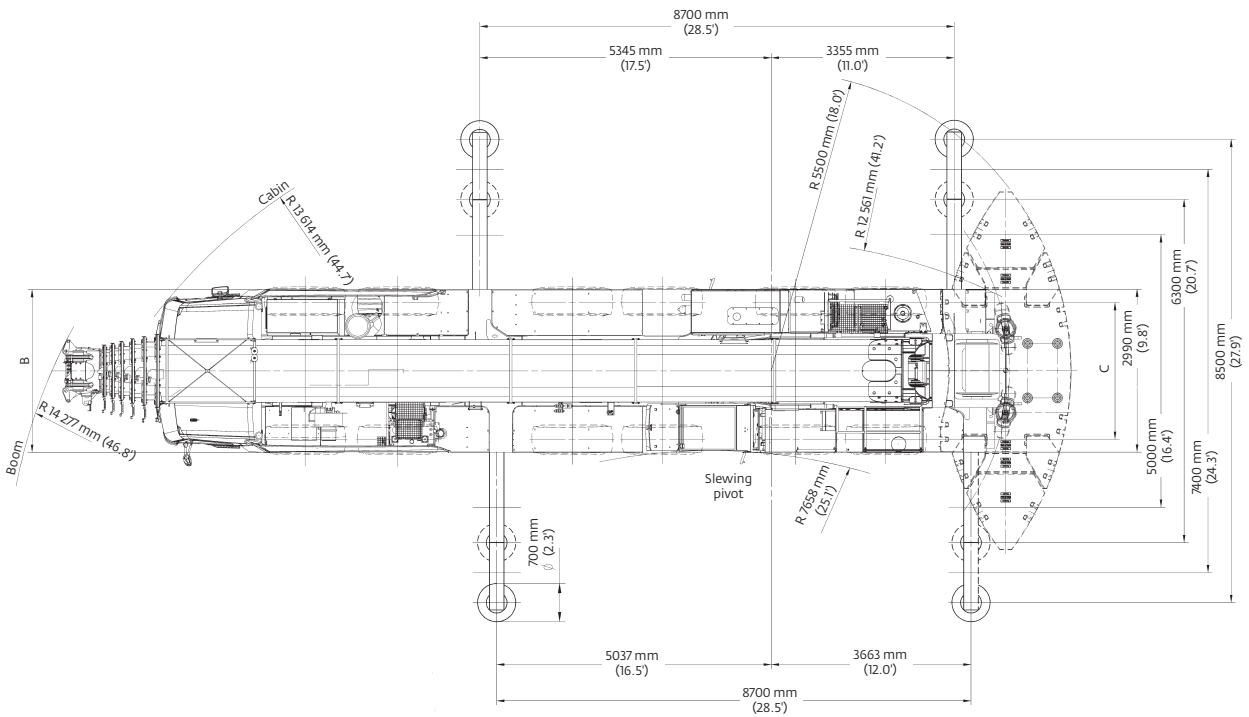
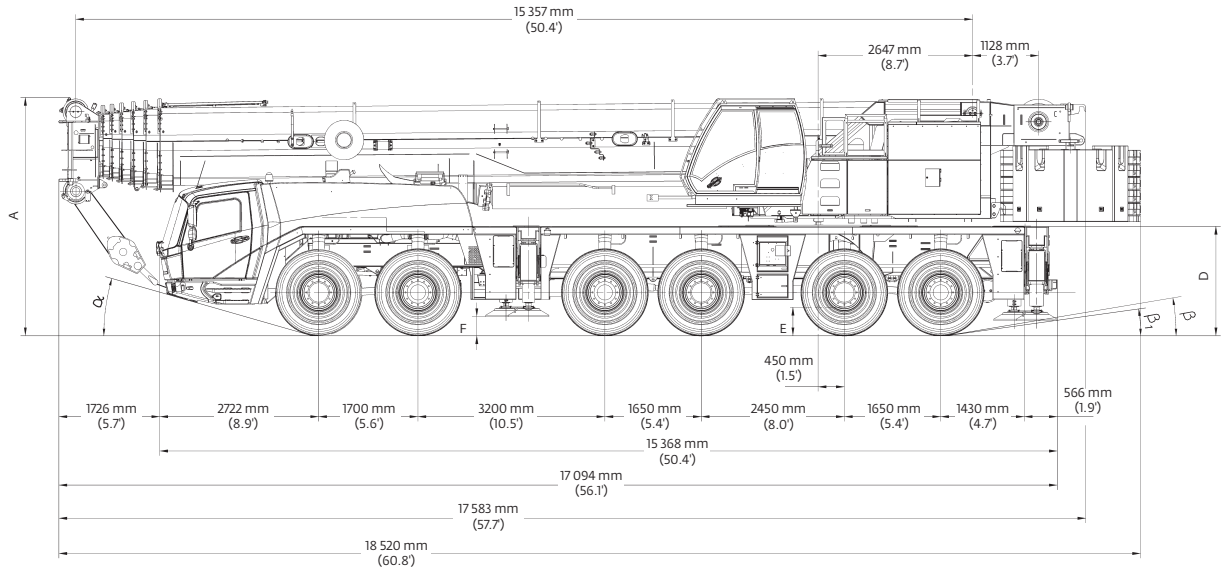

Tires	A	A <sup>130 mm</sup> (0.4)	B	C	D	E	F	$\alpha$	$\beta$	$\beta_1$
14.00 R25	3950 mm (13.0')	3820 mm (12.5')	2970 mm (9.7')	2570 mm (8.4')	1822 mm (6.0')	400 mm (1.3')	297 mm (1.0')	14°	8°	6°
16.00 R25	4000 mm (13.1')	3870 mm (12.7')	2975 mm (9.8')	2510 mm (8.2')	1872 mm (6.1')	450 mm (1.5')	327 mm (1.1')	16°	10°	8°
20.5 R25	4000 mm (13.1')	3870 mm (12.7')	3070 mm (10.1')	2530 mm (8.3')	1872 mm (6.1')	450 mm (1.5')	327 mm (1.1')	16°	10°	8°

Ra = Radius all wheels steered  
 \*Lowered

# Weights

## Trailing boom

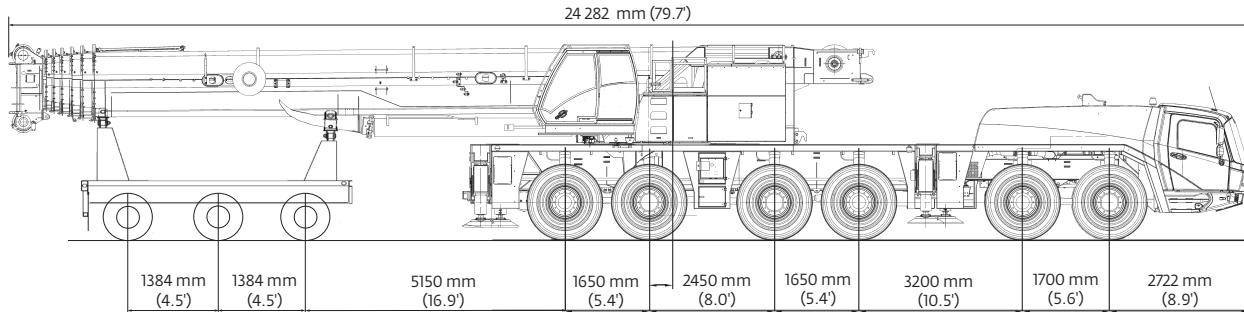

Basic Weights - kg (lb)	Axles 1 and 2		Axles 3 - 6		Three dolly axle		Total	
GMK6300L Tier IVi, Mercedes-Benz power with 20.5 R25 tires, 12x8x12 drive/steer, retarder, 12 m - 21 m (39 ft - 69 ft) hydraulic luffing swingaway, 2nd oil cooler, outrigger pads, auxiliary hoist, driver and tanks filled, three-axle boom dolly (5000 kg [11,023 lb])	15 377 kg	33,899 lb	42 184 kg	92,999 lb	26 027 kg	57,379 lb	83 588 kg	184,277 lb
<b>Additions:</b>								
7000 kg (15,400 lb) base section stowed on carrier	3390 kg	7474 lb	3270 kg	7209 lb	0 kg	0 lb	6660 kg	14,683 lb
<b>Removals:</b>								
12 m - 21 m (39 ft - 69 ft) hydraulic swingaway	- 73 kg	-161 lb	- 196 kg	-432 lb	-1738 kg	-3832 lb	-2007 kg	-4425 lb
Front outriggers	-1596 kg	-3518 lb	- 930 kg	-2050 lb	0 kg	0 lb	-2526 kg	-5569 lb
Removable rear outrigger box	3055 kg	6735 lb	-7948 kg	-17,522 lb	0 kg	0 lb	-4892 kg	-10,785 lb
Front and rear outrigger floats	- 1 kg	-2 lb	- 281 kg	-619 lb	0 kg	0 lb	- 282 kg	-622 lb
<b>Substitutions:</b>								
12x6x12 drive/steer	155 kg	342 lb	- 567 kg	-1250 lb	0 kg	0 lb	- 412 kg	-908 lb
14.00R25 tires	- 367 kg	-809 lb	- 753 kg	-1660 lb	0 kg	0 lb	-1129 kg	-2489 lb
16.00R25 tires	- 148 kg	-326 lb	- 297 kg	-655 lb	0 kg	0 lb	- 645 kg	-981 lb

## Boom over front

Basic Weights - kg (lb)	Axles 1 and 2		Axles 3 - 6		Total	
Mercedes-Benz power Tier IVi, 16.00 R25 tires, 12x6x12 drive/steer, retarder, 2nd oil cooler, outrigger pads, driver and tanks filled, removable rear outrigger box installed	22 298 kg	49,158 lb	50 746 kg	111,875 lb	73 045 kg	161,033 lb
<b>Additions:</b>						
12x8x12 drive/steer	- 157 kg	-346 lb	569 kg	1254 lb	412 kg	908 lb
Hose reel + parts for hydraulic swingaway	211 kg	465 lb	159 kg	351 lb	370 kg	816 lb
12 m - 21 m (39 ft - 69 ft) hydraulic swingaway	1840 kg	4057 lb	167 kg	368 lb	2007 kg	4425 lb
Auxiliary hoist	-1813 kg	-3997 lb	4067 kg	8966 lb	2254 kg	4969 lb
7000 kg (15,400 lb) base plate stowed on carrier	3390 kg	7474 lb	3270 kg	7209 lb	6660 kg	14,683 lb
<b>Substitutions:</b>						
14.00R25 tires	- 241 kg	-531 lb	- 481 kg	-1060 lb	- 722 kg	-1592 lb
20.5R25 tires	172 kg	379 lb	343 kg	756 lb	515 kg	1135 lb
<b>Removals:</b>						
Front and rear outrigger floats	- 1 kg	-2 lb	- 281 kg	-619 lb	- 282 kg	-622 lb
Front outriggers	-1596 kg	-3519 lb	-930 kg	-2050 lb	-2526 kg	-5569 lb
Removable rear outrigger box	3055 kg	6735 lb	-7948 kg	-17,522 lb	-4892 kg	-10,785 lb
Main boom	-11 480 kg	-25,309 lb	-16 075 kg	-35,439 lb	-27 555 kg	-60,748 lb



# Counterweight

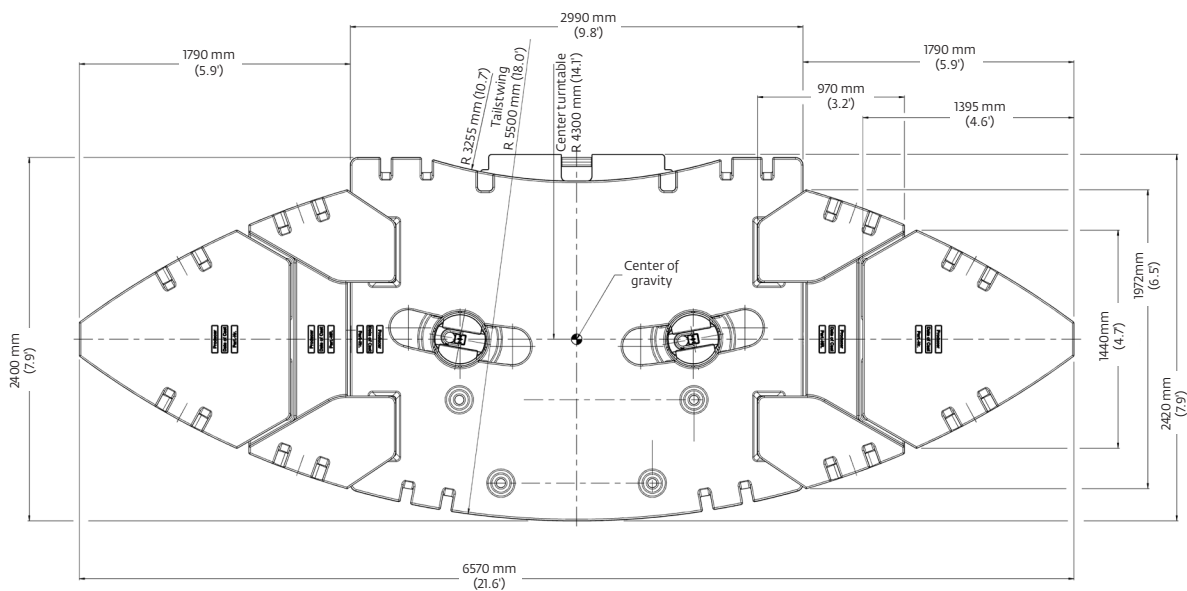
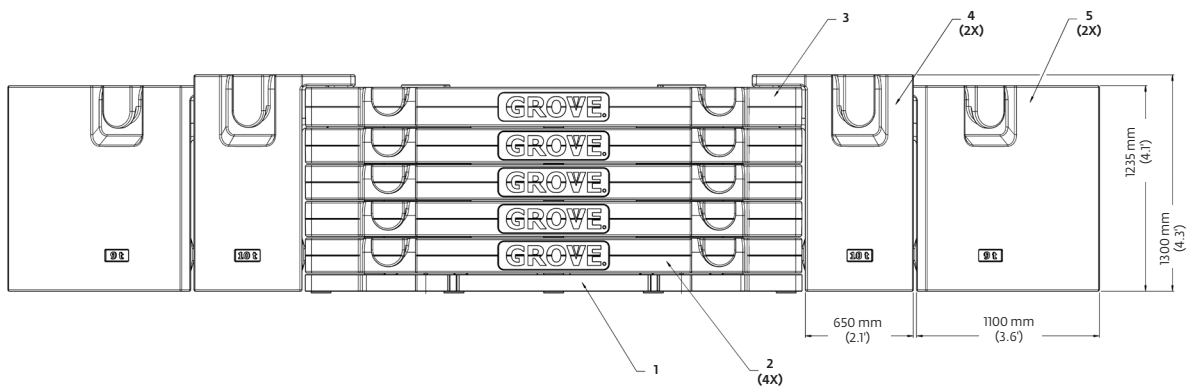

	<b>1</b> 7,0 t (15,430 lb)	<b>2</b> 9,5 t (20,940 lb)	<b>3</b> 9,5 t (20,940 lb)	<b>4</b> 10,0 t (22,050 lb)	<b>5</b> 9,0 t (19,840 lb)
<b>7,0 t (15,400 lb)</b>	X	-	-	-	-
<b>16,5 t (36,300 lb)</b>	X	X	-	-	-
<b>26,0 t (57,300 lb)</b>	X	2 X	-	-	-
<b>35,5 t (78,200 lb)</b>	X	3 X	-	-	-
<b>45,0 t (99,200 lb)</b>	X	4 X	-	-	-
<b>54,5 t (120,100 lb)</b>	X	4 X	X	-	-
<b>74,5 t (164,200 lb)</b>	X	4 X	X	2 X	-
<b>92,5 t (203,900 lb)</b>	X	4 X	X	2 X	2 X

# Working range

## Main boom

51 ft - 263 ft main boom

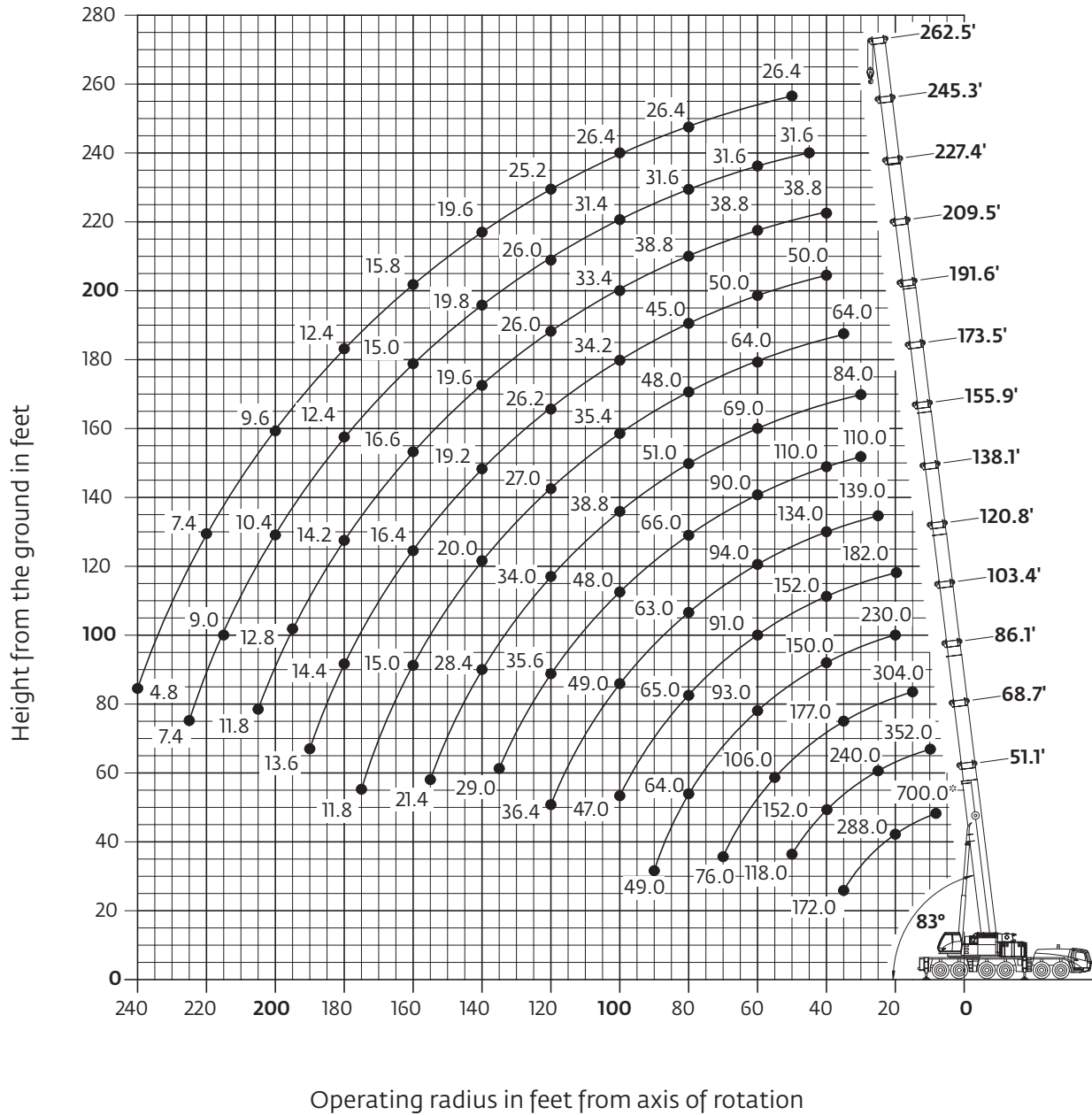

*Hook heights shown in the working diagram do not consider loaded boom deflection.*

	Hook block	H
		200 ton, 9 sheave
	160 ton, 7 sheave	12.0 ft (3650 mm)
	125 ton, 5 sheave	10.8 ft (3300 mm)
	80 ton, 3 sheave	10.8 ft (3300 mm)
	32 ton, 1 sheave	10.5 ft (3200 mm)
	12 ton, single line headache ball	8.0 ft (2450 mm)

# Load charts

## Main boom





15,6 m - 80 m  
 (51.1 ft - 262.5 ft)

92 500 kg  
 (203,900 lb)

27 ft 9 in spread  
 (100%)

360°

Feet	Pounds x 1000													
	51.1	68.7	86.1	103.4	120.8	138.1	155.9	173.5	191.6	209.5	227.4	245.3	262.5	
8.0	700.0*													
10.0	418.0	352.0												
15.0	348.0	324.0	304.0											
20.0	288.0	276.0	260.0	230.0	182.0									
25.0	244.0	240.0	230.0	217.0	178.0	139.0								
30.0	207.0	207.0	202.0	192.0	178.0	139.0	110.0	84.0						
35.0	172.0	178.0	177.0	171.0	167.0	139.0	110.0	84.0	64.0					
40.0		152.0	152.0	150.0	152.0	134.0	110.0	84.0	64.0	50.0	38.8			
45.0		134.0	132.0	130.0	132.0	124.0	106.0	84.0	64.0	50.0	38.8	31.6		
50.0		118.0	118.0	116.0	116.0	115.0	101.0	81.0	64.0	50.0	38.8	31.6	26.4	
55.0			106.0	105.0	103.0	105.0	95.0	75.0	64.0	50.0	38.8	31.6	26.4	
60.0			94.0	93.0	91.0	94.0	90.0	69.0	64.0	50.0	38.8	31.6	26.4	
65.0			85.0	84.0	82.0	84.0	84.0	64.0	59.0	50.0	38.8	31.6	26.4	
70.0			76.0	76.0	76.0	76.0	79.0	59.0	55.0	50.0	38.8	31.6	26.4	
75.0				69.0	71.0	69.0	72.0	55.0	52.0	48.0	38.8	31.6	26.4	
80.0				64.0	65.0	63.0	66.0	51.0	48.0	45.0	38.8	31.6	26.4	
85.0				61.0	60.0	58.0	60.0	47.0	44.0	42.4	38.8	31.6	26.4	
90.0				49.0	55.0	55.0	56.0	43.2	40.6	39.4	37.2	31.6	26.4	
95.0					51.0	52.0	51.0	40.4	37.8	36.6	35.4	31.6	26.4	
100.0					47.0	49.0	48.0	38.8	35.4	34.2	33.4	31.4	26.4	
105.0						46.0	44.0	37.4	32.8	31.8	31.6	30.0	26.4	
110.0						43.0	41.0	36.2	30.8	30.0	29.6	28.8	26.4	
115.0						40.2	38.2	35.0	28.8	28.0	27.8	27.4	26.4	
120.0							36.4	35.6	34.0	27.0	26.2	26.0	25.2	
125.0								33.0	33.0	25.4	24.6	24.6	24.6	
130.0								30.6	32.0	23.8	23.0	23.0	23.4	
135.0								29.0	30.6	22.0	21.2	21.2	21.6	
140.0									28.4	20.0	19.2	19.6	19.6	
145.0									26.6	18.2	18.2	18.8	18.0	
150.0									24.8	17.2	17.6	18.0	17.0	
155.0									21.4	16.0	17.0	17.2	16.0	
160.0										15.0	16.4	16.6	15.0	
165.0										14.0	15.8	16.0	14.4	
170.0										13.2	15.4	15.4	13.8	
175.0										11.8	14.8	14.8	13.0	
180.0											14.4	14.2	12.4	
185.0											14.0	13.8	12.0	
190.0											13.6	13.2	11.4	
195.0												12.8	10.8	
200.0												12.2	10.4	
205.0												11.8	9.8	
210.0													9.4	
215.0													9.0	
220.0													8.6	
225.0													7.4	
230.0														6.4
235.0														5.6
240.0														4.8

\* Over the rear with special equipment

Loads greater than 376,000 lb can only be lifted with special equipment.

THIS CHART IS ONLY A GUIDE AND SHOULD NOT BE USED TO OPERATE THE CRANE.

# Load charts

## Main boom

 15,6 m - 80 m  
 (51.1 ft - 262.5 ft)

 74 500 kg  
 (164,200 lb)

 27 ft 9 in spread  
 (100%)



 360°



Feet	51.1	68.7	86.1	103.4	120.8	138.1	155.9	173.5	191.6	209.5	227.4	245.3	262.5
10.0	418.0	352.0											
15.0	348.0	324.0	304.0										
20.0	286.0	276.0	260.0	230.0	182.0								
25.0	240.0	240.0	230.0	217.0	178.0	139.0							
30.0	195.0	196.0	196.0	192.0	178.0	139.0	110.0	84.0					
35.0	163.0	165.0	164.0	162.0	165.0	139.0	110.0	84.0	64.0				
40.0		142.0	141.0	140.0	140.0	134.0	110.0	84.0	64.0	50.0	38.8		
45.0		122.0	123.0	122.0	120.0	121.0	106.0	84.0	64.0	50.0	38.8	31.6	
50.0		107.0	108.0	107.0	105.0	105.0	101.0	81.0	64.0	50.0	38.8	31.6	26.4
55.0		95.0	94.0	96.0	93.0	93.0	94.0	75.0	64.0	50.0	38.8	31.6	26.4
60.0			85.0	84.0	86.0	83.0	84.0	69.0	64.0	50.0	38.8	31.6	26.4
65.0			76.0	78.0	78.0	74.0	75.0	64.0	59.0	50.0	38.8	31.6	26.4
70.0			69.0	71.0	70.0	69.0	68.0	59.0	55.0	50.0	38.8	31.6	26.4
75.0				65.0	64.0	65.0	62.0	55.0	52.0	48.0	38.8	31.6	26.4
80.0				59.0	58.0	60.0	56.0	51.0	48.0	45.0	38.8	31.6	26.4
85.0				54.0	52.0	55.0	52.0	47.0	44.0	42.4	38.8	31.6	26.4
90.0				49.0	49.0	50.0	47.0	43.2	40.6	39.4	37.2	31.6	26.4
95.0					47.0	46.0	43.4	40.4	37.8	36.6	35.4	31.6	26.4
100.0					43.6	42.0	39.6	38.8	35.0	34.2	33.4	31.4	26.4
105.0						38.4	36.0	37.4	32.2	31.6	31.6	30.0	26.4
110.0						35.4	33.6	35.2	29.4	29.0	29.4	28.8	26.4
115.0						32.6	32.6	32.4	27.0	26.6	27.0	27.4	26.4
120.0						30.0	31.4	29.8	24.8	24.4	25.0	25.6	25.2
125.0							30.0	27.4	22.6	22.6	23.8	23.6	24.2
130.0							27.8	25.4	20.4	21.4	22.2	21.8	22.6
135.0								25.8	23.4	18.4	20.0	20.8	20.8
140.0									21.6	17.4	19.0	19.6	19.6
145.0									20.0	16.8	18.2	18.8	18.2
150.0									18.4	16.0	17.6	18.0	16.8
155.0									17.0	15.4	17.0	17.2	15.8
160.0										15.0	16.4	16.6	15.0
165.0										14.4	15.8	16.0	14.4
170.0										14.0	14.8	14.8	13.8
175.0										13.4	13.8	13.6	12.8
180.0											12.8	12.6	11.8
185.0											12.4	11.6	10.8
190.0											11.8	10.8	9.8
195.0												9.8	7.2
200.0												9.0	6.2
205.0												8.6	7.2
210.0													6.6
215.0													5.8
220.0													5.0
225.0													4.4

Loads greater than 376,000 lb can only be lifted with special equipment.

# Load charts

## Main boom

													
 <b>Pounds x 1000</b>													
Feet	51.1	68.7	86.1	103.4	120.8	138.1	155.9	173.5	191.6	209.5	227.4	245.3	262.5
10.0	418.0	352.0											
15.0	344.0	324.0	304.0										
20.0	278.0	276.0	260.0	230.0	182.0								
25.0	219.0	220.0	220.0	217.0	178.0	139.0							
30.0	177.0	180.0	177.0	175.0	164.0	139.0	110.0	84.0					
35.0	145.0	149.0	150.0	145.0	140.0	131.0	110.0	84.0	64.0				
40.0		126.0	126.0	121.0	119.0	111.0	110.0	84.0	64.0	50.0	38.8		
45.0		108.0	109.0	108.0	102.0	96.0	95.0	84.0	64.0	50.0	38.8	31.6	
50.0		95.0	94.0	94.0	88.0	89.0	83.0	77.0	64.0	50.0	38.8	31.6	26.4
55.0			81.0	82.0	77.0	78.0	73.0	68.0	64.0	50.0	38.8	31.6	26.4
60.0			73.0	73.0	71.0	69.0	65.0	60.0	57.0	50.0	38.8	31.6	26.4
65.0			64.0	64.0	66.0	62.0	58.0	53.0	51.0	50.0	38.8	31.6	26.4
70.0			57.0	57.0	60.0	56.0	52.0	51.0	46.0	44.0	38.8	31.6	26.4
75.0				51.0	54.0	51.0	46.0	48.0	40.8	39.8	38.4	31.6	26.4
80.0				48.0	48.0	46.0	42.6	43.2	36.6	35.8	36.0	31.6	26.4
85.0				43.8	43.4	41.6	40.8	39.4	32.8	32.8	33.4	31.6	26.4
90.0				39.8	39.2	37.4	39.0	36.0	29.6	31.0	32.0	31.6	26.4
95.0					35.4	34.4	36.2	32.8	27.8	29.6	30.6	30.6	26.4
100.0					32.2	33.2	33.0	30.0	26.4	28.2	29.2	28.0	25.4
105.0						31.8	30.0	27.4	25.0	27.0	27.4	25.8	23.2
110.0						29.2	27.4	24.8	24.0	25.8	25.2	23.6	21.2
115.0						26.8	25.0	22.4	22.8	24.2	23.8	21.6	19.2
120.0						24.6	22.8	20.2	21.4	23.0	22.0	20.0	17.6
125.0							20.8	18.2	19.6	22.0	19.8	18.2	16.0
130.0							19.0	16.4	18.8	20.4	18.8	16.8	14.4
135.0								17.4	14.8	18.2	17.2	15.4	13.0
140.0									13.2	17.4	17.2	15.6	11.8
145.0									11.8	16.0	15.8	14.2	10.6
150.0									10.6	14.8	14.4	13.0	9.4
155.0										9.4	14.0	11.6	8.4
160.0											12.8	10.6	7.2
165.0											11.8	9.4	6.2
170.0											10.8	10.0	5.2
175.0											9.8	9.0	4.2
180.0												8.0	6.6
185.0													5.2
190.0													4.4
195.0													3.6
200.0													2.8
205.0													3.0
210.0													3.0

													
 <b>Pounds x 1000</b>													
Feet	51.1	68.7	86.1	103.4	120.8	138.1	155.9	173.5	191.6	209.5	227.4	245.3	262.5
10.0	418.0	352.0											
15.0	340.0	324.0	304.0										
20.0	268.0	266.0	260.0	230.0	182.0								
25.0	209.0	210.0	210.0	193.0	178.0	139.0							
30.0	166.0	170.0	169.0	157.0	152.0	139.0	110.0	84.0					
35.0	137.0	140.0	136.0	132.0	125.0	116.0	110.0	84.0	64.0				
40.0		119.0	113.0	111.0	105.0	102.0	97.0	84.0	64.0	50.0	38.8		
45.0		99.0	96.0	95.0	90.0	89.0	83.0	77.0	64.0	50.0	38.8	31.6	
50.0		83.0	86.0	82.0	83.0	78.0	72.0	67.0	64.0	50.0	38.8	31.6	26.4
55.0			73.0	72.0	73.0	68.0	63.0	59.0	56.0	50.0	38.8	31.6	26.4
60.0			63.0	63.0	64.0	60.0	56.0	56.0	49.0	48.0	38.8	31.6	26.4
65.0			56.0	58.0	58.0	54.0	50.0	50.0	43.2	42.0	38.8	31.6	26.4
70.0			51.0	52.0	51.0	48.0	48.0	45.0	38.2	38.4	38.0	31.6	26.4
75.0				46.0	46.0	43.4	45.0	40.6	34.6	36.4	36.6	31.6	26.4
80.0				41.2	40.6	39.2	40.6	36.8	32.6	34.4	34.8	31.6	26.4
85.0				36.8	36.2	37.6	37.0	33.2	30.8	32.8	33.0	30.6	26.4
90.0				33.0	32.6	35.2	33.4	30.0	29.2	30.6	30.2	27.8	25.2
95.0					31.2	31.8	30.0	27.2	27.8	29.2	27.6	25.4	22.8
100.0					29.8	28.8	27.0	24.4	26.4	27.4	25.2	23.0	20.6
105.0						26.2	24.4	21.8	25.0	25.2	23.0	21.0	18.4
110.0						23.8	22.0	19.4	23.8	23.2	21.2	19.0	16.6
115.0						21.8	20.0	17.2	21.6	21.4	19.4	17.4	15.0
120.0						19.8	18.0	15.4	19.8	19.4	17.6	15.8	13.4
125.0							16.2	13.6	18.4	17.6	16.2	14.2	11.8
130.0							15.2	12.0	16.8	16.0	14.6	12.8	10.6
135.0								14.4	10.6	15.2	14.4	11.4	9.2
140.0									9.2	13.8	13.2	11.6	8.0
145.0									8.0	12.6	11.8	10.4	8.8
150.0									6.8	11.4	10.6	9.2	7.6
155.0									5.8	10.4	9.6	8.0	6.6
160.0										9.4	8.4	7.0	5.6
165.0										8.4	7.6	6.0	4.6
170.0										7.4	6.6	5.2	3.6
175.0										6.6	5.8	4.4	2.8
180.0											5.0	3.6	
185.0											4.2	2.8	
190.0												3.6	

Loads greater than 376,000 lb can only be lifted with special equipment.



# Load charts

## Main boom

		15,6 m - 80 m (51.1 ft - 262.5 ft)		35 500 kg (78,200 lb)		27 ft 9 in spread (100%)		360°		Pounds x 1000											
Feet	51.1	68.7	86.1	103.4	120.8	138.1	155.9	173.5	191.6	209.5	227.4	245.3	262.5								
10.0	418.0	352.0																			
15.0	336.0	324.0	304.0																		
20.0	256.0	258.0	256.0	230.0	182.0																
25.0	197.0	199.0	190.0	177.0	169.0	139.0															
30.0	156.0	157.0	148.0	143.0	133.0	122.0	110.0	84.0													
35.0	123.0	128.0	119.0	116.0	109.0	107.0	99.0	84.0	64.0												
40.0		104.0	102.0	97.0	96.0	90.0	83.0	77.0	64.0	50.0	38.8										
45.0		84.0	86.0	82.0	83.0	77.0	71.0	67.0	62.0	50.0	38.8	31.6									
50.0		69.0	72.0	73.0	71.0	67.0	61.0	62.0	54.0	50.0	38.8	31.6	26.4								
55.0			64.0	66.0	63.0	58.0	56.0	54.0	47.0	46.0	38.8	31.6	26.4								
60.0			55.0	57.0	55.0	51.0	53.0	48.0	41.4	42.8	38.8	31.6	26.4								
65.0			48.0	49.0	49.0	47.0	47.0	42.4	38.8	40.4	38.0	31.6	26.4								
70.0			42.0	43.2	42.6	44.0	41.8	37.8	36.6	37.6	36.6	31.6	26.4								
75.0				38.0	37.4	40.4	37.6	33.6	34.6	35.6	33.4	30.8	26.4								
80.0				33.6	35.6	35.8	34.0	30.0	32.6	32.4	30.0	27.4	24.6								
85.0				30.0	32.8	32.0	30.2	26.8	30.6	29.4	27.0	24.6	21.8								
90.0				28.8	29.4	28.6	26.8	24.0	28.2	26.6	24.4	22.0	19.4								
95.0					26.4	26.2	23.8	21.2	25.6	24.2	22.0	19.8	17.2								
100.0					23.8	25.0	21.2	18.6	23.4	22.0	19.8	17.6	15.2								
105.0						22.8	19.4	16.2	21.2	20.0	17.8	15.8	13.4								
110.0						20.6	18.6	14.2	19.0	18.2	16.2	14.0	11.6								
115.0						18.8	17.6	12.2	17.2	16.4	14.4	12.4	10.2								
120.0						17.0	16.6	10.6	15.4	14.6	13.0	11.0	8.8								
125.0							15.2	9.0	13.8	13.0	11.6	9.8	7.4								
130.0							13.8	7.6	12.4	11.6	10.2	8.4	6.2								
135.0								12.4	6.4	11.0	10.2	8.8	7.2								
140.0									5.2	9.8	9.0	7.6	6.0								
145.0									4.0	8.8	8.0	6.4	5.0								
150.0									3.0	7.6	6.8	5.4	4.0								
155.0										6.6	5.8	4.4	3.0								
160.0										5.8	5.0	3.6									
165.0										5.0	4.2	2.6									
170.0										4.2	3.4										
175.0										3.4											

		15,6 m - 80 m (51.1 ft - 262.5 ft)		26 000 kg (57,300 lb)		27 ft 9 in spread (100%)		360°		Pounds x 1000											
Feet	51.1	68.7	86.1	103.4	120.8	138.1	155.9	173.5	191.6	209.5	227.4	245.3	262.5								
10.0	418.0	352.0																			
15.0	330.0	324.0	304.0																		
20.0	244.0	246.0	222.0	197.0	182.0																
25.0	185.0	179.0	166.0	159.0	146.0	133.0															
30.0	137.0	137.0	130.0	123.0	114.0	112.0	103.0	84.0													
35.0	101.0	109.0	105.0	99.0	99.0	92.0	84.0	77.0	64.0												
40.0		86.0	87.0	87.0	82.0	77.0	70.0	70.0	61.0	50.0	38.8										
45.0		69.0	73.0	74.0	70.0	65.0	64.0	60.0	51.0	49.0	38.8	31.6									
50.0		58.0	63.0	64.0	60.0	56.0	57.0	52.0	48.0	47.0	38.8	31.6	26.4								
55.0			53.0	54.0	52.0	52.0	49.0	45.0	45.0	43.6	38.0	31.6	26.4								
60.0			45.0	46.0	46.0	47.0	43.2	38.6	41.4	40.6	36.8	31.6	26.4								
65.0			38.4	39.8	41.8	41.4	38.0	33.8	37.8	35.8	33.0	30.2	26.4								
70.0			33.0	35.0	37.6	36.8	33.6	29.4	33.8	31.8	29.2	26.6	23.6								
75.0				32.4	33.0	32.8	29.8	25.8	30.2	28.4	26.0	23.4	20.6								
80.0				28.6	29.2	30.6	27.8	22.6	27.0	25.4	23.0	20.6	18.0								
85.0				25.2	25.8	27.2	26.2	19.8	24.2	22.8	20.4	18.2	15.6								
90.0				22.4	22.8	24.2	24.0	17.4	21.8	20.4	18.2	16.0	13.4								
95.0					20.2	21.6	21.4	15.0	19.6	18.2	16.0	14.0	11.4								
100.0					18.0	19.2	19.2	12.8	17.6	16.2	14.2	12.2	9.6								
105.0						17.2	17.0	10.6	15.6	14.6	12.6	10.4	8.0								
110.0						15.4	15.2	9.0	13.8	13.0	11.0	9.0	6.6								
115.0						13.8	13.6	7.2	12.2	11.4	9.6	7.6	5.4								
120.0						12.2	12.0	5.8	10.6	9.8	8.2	6.4	4.0								
125.0							10.6	4.4	9.2	8.4	7.0	5.2	3.0								
130.0							9.4	3.2	8.0	7.2	5.8	4.2									
135.0									6.8	6.0	4.6	3.0									
140.0									5.8	5.0	3.6										
145.0									4.8	4.0											
150.0									4.0	3.2											
155.0									3.0												





Loads greater than 376,000 lb can only be lifted with special equipment.

THIS CHART IS ONLY A GUIDE AND SHOULD NOT BE USED TO OPERATE THE CRANE.

The individual crane's load chart, operating instructions and other instructional plates must be read and understood prior to operating the crane





# Load charts

## Main boom





15,6 m - 80 m (51.1 ft - 262.5 ft)    16 500 kg (36,400 lb)    27 ft 9 in spread (100%)    360°

Feet	51.1	68.7	86.1	103.4	120.8	138.1	155.9	173.5	191.6	209.5	227.4	245.3	262.5
10.0	418.0	352.0											
15.0	320.0	320.0	292.0										
20.0	228.0	209.0	190.0	182.0	164.0								
25.0	159.0	153.0	144.0	134.0	122.0	119.0							
30.0	109.0	114.0	110.0	105.0	101.0	94.0	85.0	79.0					
35.0	79.0	88.0	87.0	88.0	82.0	76.0	74.0	68.0	58.0				
40.0		68.0	75.0	72.0	68.0	64.0	63.0	56.0	53.0	47.0	38.8		
45.0		55.0	60.0	60.0	56.0	57.0	53.0	47.0	50.0	46.0	38.0	31.6	
50.0		45.0	49.0	51.0	52.0	49.0	45.0	39.8	43.8	41.4	37.4	31.6	26.4
55.0			40.8	42.2	45.0	43.0	39.6	33.8	38.0	35.8	32.8	29.8	26.4
60.0			34.2	38.4	39.0	38.8	36.6	28.8	33.2	31.2	28.4	25.6	22.4
65.0			29.2	32.8	33.4	34.2	32.8	24.6	29.0	27.2	24.6	22.0	19.0
70.0			24.8	28.2	29.4	30.2	29.0	21.0	25.6	23.8	21.4	18.8	16.0
75.0				24.4	25.4	26.2	25.6	18.0	22.4	20.8	18.6	16.0	13.2
80.0				21.0	22.2	23.0	22.8	15.2	19.8	18.2	16.0	13.6	11.0
85.0				18.2	19.2	20.0	20.0	12.8	17.4	16.0	13.6	11.4	8.8
90.0				15.8	16.8	17.6	17.4	10.6	15.2	13.8	11.6	9.4	7.0
95.0					14.6	15.4	15.2	8.6	13.4	12.0	9.8	7.8	5.2
100.0					12.6	13.4	13.2	6.8	11.6	10.4	8.2	6.2	3.8
105.0						11.6	11.6	5.2	10.0	8.8	6.8	4.8	
110.0						10.2	10.0	3.6	8.6	7.4	5.4	3.6	
115.0						8.8	8.6		7.2	6.2	4.2		
120.0						7.4	7.2		5.8	5.0	3.2		
125.0							6.0		4.6	4.0			
130.0							5.0		3.6	2.8			
135.0							4.0		2.6				

15,6 m - 80 m (51.1 ft - 262.5 ft)    7000 kg (15,400 lb)    27 ft 9 in spread (100%)    360°

Feet	51.1	68.7	86.1	103.4	120.8	138.1	155.9	173.5	191.6
10.0	414.0	352.0							
15.0	304.0	288.0	248.0						
20.0	191.0	178.0	165.0	150.0	134.0				
25.0	125.0	124.0	118.0	115.0	106.0	96.0			
30.0	82.0	91.0	92.0	87.0	81.0	77.0	73.0	60.0	
35.0	58.0	68.0	71.0	69.0	66.0	64.0	58.0	58.0	49.0
40.0		52.0	57.0	55.0	56.0	55.0	47.0	49.0	46.0
45.0		40.0	45.0	48.0	47.0	46.0	39.0	41.4	38.2
50.0		31.2	36.2	40.2	39.6	38.8	32.2	34.8	32.0
55.0			29.6	33.2	33.4	32.8	26.6	29.4	27.0
60.0			24.2	27.6	28.4	28.0	22.2	25.0	22.8
65.0			19.6	23.2	24.2	24.0	18.4	21.4	19.2
70.0			16.0	19.4	20.6	20.6	15.4	18.2	16.4
75.0				16.2	17.4	17.6	12.6	15.6	13.8
80.0				13.4	14.6	15.2	10.2	13.4	11.6
85.0				11.2	12.2	13.0	8.2	11.2	9.6
90.0				9.2	10.2	11.0	6.4	9.6	7.8
95.0					8.4	9.2	4.8	8.0	6.4
100.0					6.8	7.6	3.4	6.6	5.0
105.0						6.2		5.2	3.8
110.0						4.8		4.0	2.6
115.0						3.8		3.0	
120.0						2.8			

15,6 m - 80 m (51.1 ft - 262.5 ft)    0 kg (0 lb)    27 ft 9 in spread (100%)    360°

Feet	51.1	68.7	86.1	103.4	120.8	138.1	155.9	173.3	191.6
10.0	410.0	352.0							
15.0	290.0	252.0	211.0						
20.0	160.0	151.0	140.0	128.0	121.0				
25.0	98.0	103.0	102.0	96.0	87.0	84.0			
30.0	62.0	74.0	74.0	70.0	70.0	67.0	58.0	59.0	
35.0	42.4	53.0	57.0	58.0	56.0	53.0	45.0	47.0	42.8
40.0		39.0	43.4	46.0	44.0	42.6	35.0	37.4	34.2
45.0		29.2	34.6	36.4	35.6	34.6	27.8	30.6	27.6
50.0		21.8	27.2	29.4	29.0	28.4	22.2	25.0	22.6
55.0			21.4	24.0	23.8	23.6	17.6	20.6	18.4
60.0			16.8	19.6	19.8	19.6	14.0	17.0	15.0
65.0			13.0	16.2	16.2	16.2	11.0	14.0	12.0
70.0			9.8	13.2	13.4	13.4	8.4	11.4	9.6
75.0				10.4	11.0	11.0	6.2	9.2	7.6
80.0				8.2	8.8	9.0	4.2	7.4	5.8
85.0				6.2	7.0	7.2		5.8	4.2
90.0				4.6	5.4	5.8		4.2	2.8
95.0					4.0	4.4		3.0	
100.0					2.6	3.2			

Loads greater than 376,000 lb can only be lifted with special equipment.

THIS CHART IS ONLY A GUIDE AND SHOULD NOT BE USED TO OPERATE THE CRANE.

The individual crane's load chart, operating instructions and other instructional plates must be read and understood prior to operating the crane

# Working range

## Hydraulic offsettable swingaway

263 ft main boom with 39 ft - 69 ft swingaway

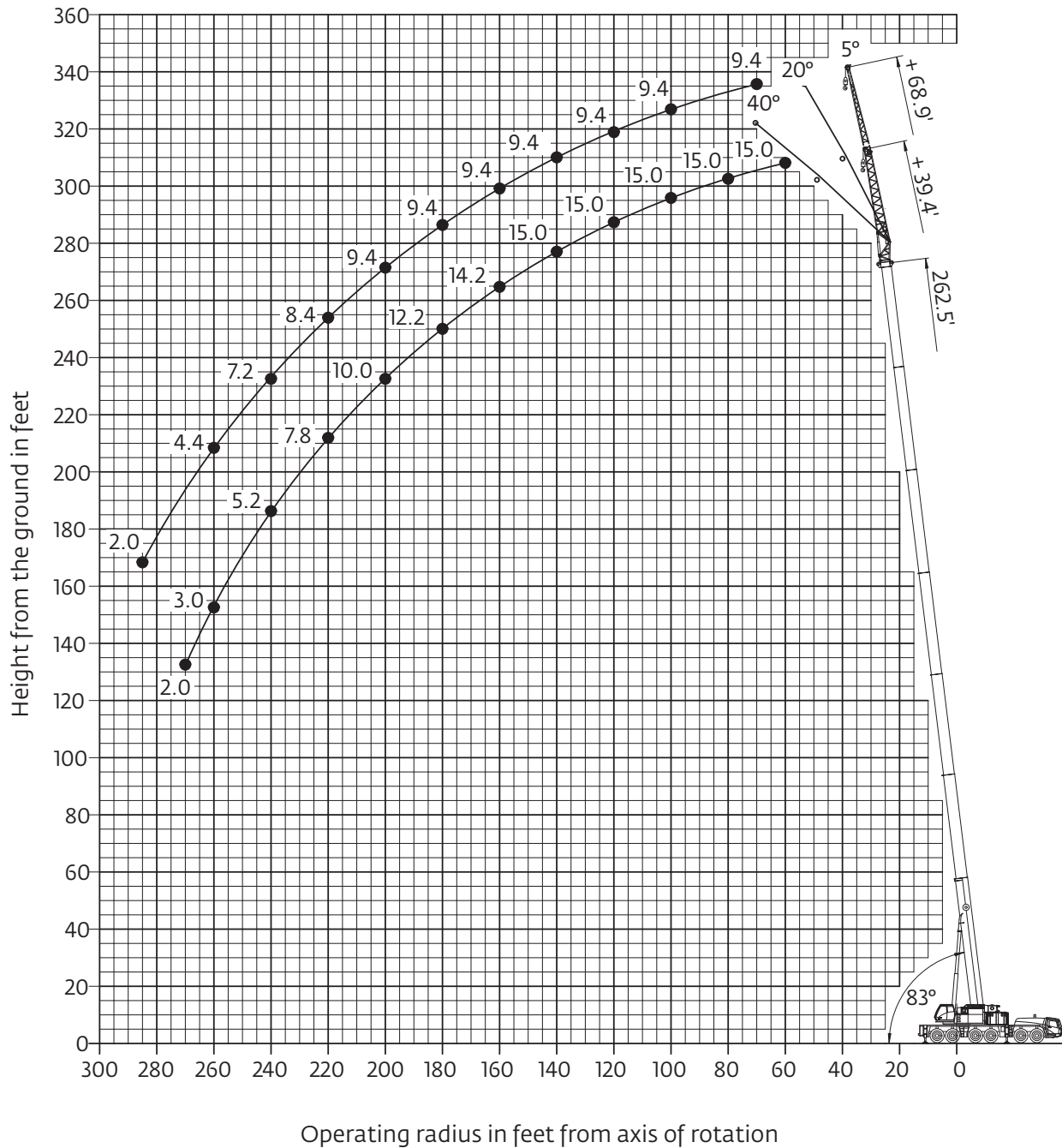

*Hook heights shown in the working diagram do not consider loaded boom deflection.*

# Load charts

## Hydraulic offsettable swingaway

### Intermediate angle and loads for luffing



74.8 m - 80 m  
(245 ft - 263 ft)



12 m - 21 m  
(39 ft - 69 ft)



92 500 kg  
(203,900 lb)



27 ft 9 in spread  
(100%)



360°



Pounds x 1000

Feet	245.3' + 39.4'			262.5' + 39.4'			245.3' + 68.9'			262.5' + 68.9'		
	5°	5°- 20°	20°- 40°	5°	5°- 20°	20°- 40°	5°	5°- 20°	20°- 40°	5°	5°- 20°	20°- 40°
55.0	18.6											
60.0	18.6	18.0		15.0	14.8							
65.0	18.6	18.0		15.0	14.8							
70.0	18.6	18.0		15.0	14.8		11.0			9.4		
75.0	18.6	18.0	18.0	15.0	14.8		11.0			9.4		
80.0	18.6	18.0	17.8	15.0	14.8	14.8	11.0	11.0		9.4	9.4	
85.0	18.6	18.0	17.6	15.0	14.8	14.8	11.0	11.0		9.4	9.4	
90.0	18.6	18.0	17.6	15.0	14.8	14.8	11.0	11.0		9.4	9.4	
95.0	18.6	18.0	17.4	15.0	14.8	14.8	11.0	11.0		9.4	9.4	
100.0	18.6	18.0	17.2	15.0	14.8	14.8	11.0	11.0	9.6	9.4	9.4	
105.0	18.6	18.0	17.2	15.0	14.8	14.8	11.0	11.0	9.4	9.4	9.4	9.4
110.0	18.6	18.0	17.0	15.0	14.8	14.8	11.0	11.0	9.4	9.4	9.4	9.2
115.0	18.6	18.0	17.0	15.0	14.8	14.8	11.0	10.8	9.2	9.4	9.4	9.2
120.0	18.6	18.0	16.8	15.0	14.8	14.8	11.0	10.6	9.2	9.4	9.4	9.2
125.0	18.6	18.0	16.8	15.0	14.8	14.8	11.0	10.6	9.2	9.4	9.4	9.0
130.0	18.6	18.0	16.6	15.0	14.8	14.8	11.0	10.4	9.0	9.4	9.4	9.0
135.0	18.4	18.0	16.6	15.0	14.8	14.8	11.0	10.2	9.0	9.4	9.4	9.0
140.0	17.8	17.6	16.4	15.0	14.8	14.8	11.0	10.2	9.0	9.4	9.4	8.8
145.0	17.0	17.0	16.4	15.0	14.8	14.8	11.0	10.0	8.8	9.4	9.4	8.8
150.0	16.2	16.2	16.2	15.0	14.8	14.6	11.0	9.8	8.8	9.4	9.4	8.8
155.0	15.4	15.4	15.6	14.6	14.6	14.4	11.0	9.8	8.8	9.4	9.4	8.8
160.0	14.6	14.6	15.0	14.2	14.2	14.2	11.0	9.6	8.8	9.4	9.4	8.6
165.0	14.0	14.0	14.4	13.8	13.6	13.6	10.8	9.6	8.6	9.4	9.4	8.6
170.0	13.4	13.4	13.6	13.2	13.2	13.2	10.6	9.4	8.6	9.4	9.4	8.6
175.0	12.6	12.6	13.0	12.4	12.4	12.8	10.4	9.4	8.6	9.4	9.2	8.6
180.0	11.8	11.8	12.4	12.0	12.0	12.2	10.4	9.2	8.6	9.4	9.2	8.6
185.0	11.0	11.0	11.6	11.4	11.4	11.8	10.2	9.2	8.6	9.4	9.2	8.4
190.0	10.4	10.4	11.0	10.8	10.8	11.2	10.0	9.0	8.6	9.4	9.0	8.4
195.0	9.6	9.6	10.2	10.2	10.2	10.6	10.0	9.0	8.4	9.4	9.0	8.4
200.0	9.0	9.0	9.6	9.6	9.6	10.0	9.6	9.0	8.4	9.4	8.8	8.4
205.0	8.6	8.6	8.8	9.0	9.0	9.6	9.4	8.8	8.4	9.2	8.8	8.4
210.0	8.2	8.2	8.4	8.4	8.4	9.0	9.0	8.8	8.4	8.8	8.6	8.4
215.0	7.8	7.8	8.0	8.0	8.0	8.4	8.4	8.4	8.4	8.6	8.6	8.4
220.0	7.4	7.4		7.4	7.4	7.8	7.8	7.8	8.4	8.2	8.2	8.4
225.0	7.0	7.0		6.8	6.8	7.2	7.4	7.4	8.2	7.8	7.8	8.0
230.0	6.6	6.6		6.4	6.4		6.8	6.8	7.6	7.4	7.4	7.8
235.0	6.2	6.2		5.8	5.8		6.4	6.4	7.0	6.8	6.8	7.6
240.0	5.8	5.8		5.2	5.2		6.0	6.0	6.6	6.4	6.4	7.2
245.0	5.6	5.6		4.6	4.6		5.8	5.8		6.0	6.0	6.6
250.0	5.2	5.2		4.0	4.0		5.4	5.4		5.6	5.6	6.2
255.0	4.8	4.8		3.4	3.4		5.2	5.2		5.0	5.0	5.6
260.0	4.4			3.0	3.0		4.8	4.8		4.4	4.4	
265.0				2.4	2.4		4.6	4.6		4.0	4.0	
270.0				2.0	2.0		4.2	4.2		3.4	3.4	
275.0							4.0	4.0		3.0	3.0	
280.0							3.8	3.8		2.4	2.4	
285.0							3.4	3.4		2.0	2.0	

THIS CHART IS ONLY A GUIDE AND SHOULD NOT BE USED TO OPERATE THE CRANE.

# Load chart

## Hydraulic offsettable swingaway

### Intermediate angle and loads for luffing



74,8 m - 80 m  
(245 ft - 263 ft)



12 m - 21 m  
(39 ft - 69 ft)



54 500 kg  
(120,100 lb)



27 ft 9 in spread  
(100%)



360°



Pounds x 1000

Feet	245.3' + 39.4'			262.5' + 39.4'			245.3' + 68.9'			262.5' + 68.9'		
	5°	5°- 20°	20°- 40°	5°	5°- 20°	20°- 40°	5°	5°- 20°	20°- 40°	5°	5°- 20°	20°- 40°
55.0	18.6											
60.0	18.6	18.0		15.0	14.8							
65.0	18.6	18.0		15.0	14.8							
70.0	18.6	18.0		15.0	14.8		11.0			9.4		
75.0	18.6	18.0	18.0	15.0	14.8		11.0			9.4		
80.0	18.6	18.0	17.8	15.0	14.8	14.8	11.0	11.0		9.4	9.4	
85.0	18.6	18.0	17.6	15.0	14.8	14.8	11.0	11.0		9.4	9.4	
90.0	18.6	18.0	17.6	15.0	14.8	14.8	11.0	11.0		9.4	9.4	
95.0	18.6	18.0	17.4	15.0	14.8	14.8	11.0	11.0		9.4	9.4	
100.0	18.6	18.0	17.2	15.0	14.8	14.8	11.0	11.0	9.6	9.4	9.4	
105.0	18.6	18.0	17.2	15.0	14.8	14.8	11.0	11.0	9.4	9.4	9.4	9.4
110.0	18.6	18.0	17.0	15.0	14.8	14.8	11.0	11.0	9.4	9.4	9.4	9.2
115.0	18.0	18.0	17.0	15.0	14.8	14.8	11.0	10.8	9.2	9.4	9.4	9.2
120.0	17.4	17.0	16.8	15.0	14.8	14.8	11.0	10.6	9.2	9.4	9.4	9.2
125.0	17.4	16.6	16.0	15.0	14.8	14.8	11.0	10.6	9.2	9.4	9.4	9.0
130.0	16.2	16.2	15.6	14.0	14.0	14.8	11.0	10.4	9.0	9.4	9.4	9.0
135.0	14.8	14.8	15.2	12.6	12.6	13.6	11.0	10.2	9.0	9.4	9.4	9.0
140.0	13.6	13.6	14.6	11.4	11.4	12.4	11.0	10.2	9.0	9.4	9.4	8.8
145.0	12.4	12.4	13.2	10.2	10.2	11.2	11.0	10.0	8.8	9.4	9.4	8.8
150.0	11.2	11.2	12.2	9.0	9.0	10.0	10.6	9.8	8.8	9.4	9.4	8.8
155.0	10.2	10.2	11.0	8.0	8.0	9.0	10.6	9.6	8.8	9.4	9.4	8.8
160.0	9.2	9.2	10.0	7.0	7.0	8.0	10.6	9.6	8.8	8.8	8.8	8.6
165.0	8.4	8.4	9.0	6.2	6.2	7.0	9.8	9.4	8.6	7.8	7.8	8.6
170.0	7.4	7.4	8.2	5.4	5.4	6.0	9.0	9.0	8.6	7.0	7.0	8.4
175.0	6.4	6.4	7.2	4.6	4.6	5.2	8.2	8.2	8.6	6.2	6.2	7.6
180.0	5.6	5.6	6.2	3.6	3.6	4.4	7.4	7.4	8.6	5.4	5.4	6.8
185.0	4.6	4.6	5.4	2.8	2.8	3.6	6.6	6.6	7.8	4.6	4.6	6.0
190.0	3.8	3.8	4.4	2.0	2.0	2.8	5.8	5.8	7.0	4.0	4.0	5.2
195.0	3.2	3.2	3.6			2.0	5.0	5.0	6.2	3.2	3.2	4.4
200.0	2.4	2.4	3.0				4.2	4.2	5.4	2.6	2.6	3.8
205.0			2.2				3.6	3.6	4.6			3.0
210.0							3.0	3.0	4.0			2.4
215.0							2.4	2.4	3.2			
220.0									2.6			
225.0									2.0			

THIS CHART IS ONLY A GUIDE AND SHOULD NOT BE USED TO OPERATE THE CRANE.

The individual crane's load chart, operating instructions and other instructional plates must be read and understood prior to operating the crane.



# Working range

## Hydraulic offsettable swingaway with inserts

263 ft main boom with 39 ft - 69 ft swingaway and 2 X 26 ft inserts

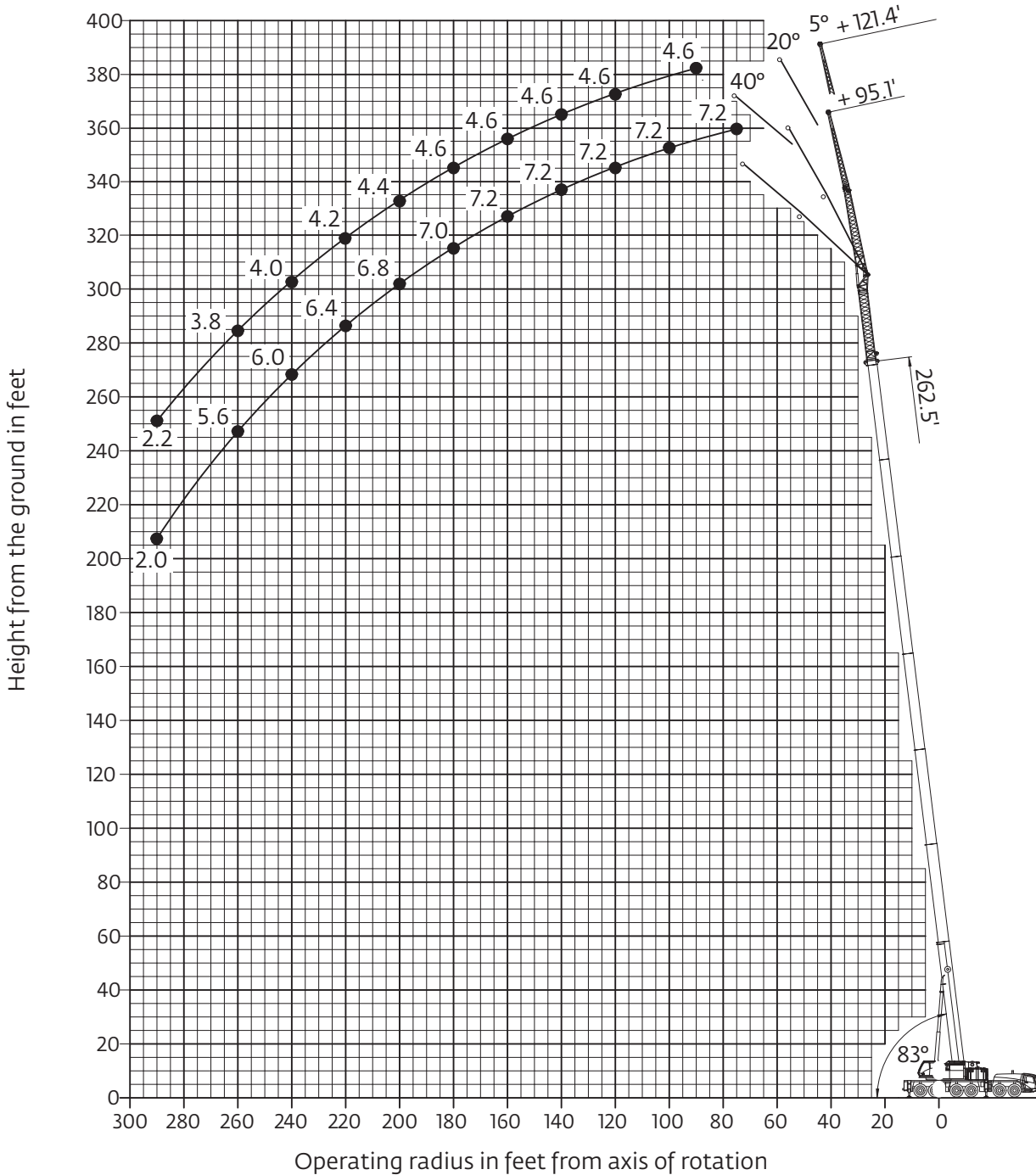

*Hook heights shown in the working diagram do not consider loaded boom deflection.*

# Load chart

## Hydraulic offsettable swingaway with inserts

  
74,8 m - 80 m  
(245 ft - 263 ft)

  
29 m - 37 m  
(95 ft - 121 ft)

  
92 500 kg  
(203,900 lb)

  
27 ft 9 in spread  
(100%)

  
360°



Pounds x 1000





Feet	245.3' + 95.1'			262.5' + 95.1'			245.3' + 121.4'			262.5' + 121.4'		
	5°	5°- 20°	20°- 40°	5°	5°- 20°	20°- 40°	5°	5°- 20°	20°- 40°	5°	5°- 20°	20°- 40°
75.0	8.4			7.2								
80.0	8.4			7.2			5.6					
85.0	8.4			7.2			5.6					
90.0	8.4			7.2			5.6					
95.0	8.4	8.4		7.2	7.2		5.6			4.6		
100.0	8.4	8.4		7.2	7.2		5.6	5.6		4.6	4.6	
105.0	8.4	8.4	7.0	7.2	7.2		5.6	5.6		4.6	4.6	
110.0	8.4	8.2	7.0	7.2	7.2		5.6	5.6		4.6	4.6	
115.0	8.4	8.2	7.0	7.2	7.2	6.2	5.6	5.6	4.4	4.6	4.6	
120.0	8.4	8.0	7.0	7.2	7.2	6.2	5.6	5.6	4.4	4.6	4.6	3.8
125.0	8.4	8.0	7.0	7.2	7.2	6.2	5.6	5.6	4.4	4.6	4.6	3.8
130.0	8.4	7.8	7.0	7.2	7.2	6.2	5.6	5.4	4.4	4.6	4.6	3.8
135.0	8.2	7.8	7.0	7.2	7.2	6.2	5.6	5.4	4.4	4.6	4.6	3.8
140.0	8.2	7.6	7.0	7.2	7.2	6.2	5.6	5.4	4.4	4.6	4.6	3.8
145.0	8.0	7.6	7.0	7.2	7.2	6.2	5.4	5.2	4.4	4.6	4.6	3.8
150.0	8.0	7.6	7.0	7.2	7.0	6.2	5.4	5.2	4.4	4.6	4.6	3.8
155.0	7.8	7.4	7.0	7.2	7.0	6.2	5.4	5.0	4.4	4.6	4.6	3.8
160.0	7.8	7.4	7.0	7.2	7.0	6.2	5.2	5.0	4.4	4.6	4.6	3.8
165.0	7.6	7.2	7.0	7.2	6.8	6.2	5.2	5.0	4.4	4.6	4.6	3.8
170.0	7.6	7.2	6.8	7.2	6.8	6.2	5.0	4.8	4.4	4.6	4.6	3.8
175.0	7.6	7.2	6.8	7.0	6.8	6.2	5.0	4.8	4.4	4.6	4.4	3.8
180.0	7.4	7.0	6.8	7.0	6.6	6.2	5.0	4.8	4.4	4.6	4.4	3.8
185.0	7.4	7.0	6.6	7.0	6.6	6.2	4.8	4.6	4.4	4.6	4.4	3.8
190.0	7.2	6.8	6.6	6.8	6.6	6.2	4.8	4.6	4.4	4.4	4.4	3.8
195.0	7.2	6.8	6.6	6.8	6.6	6.2	4.8	4.6	4.4	4.4	4.2	3.8
200.0	7.0	6.6	6.4	6.8	6.4	6.2	4.6	4.4	4.4	4.4	4.2	3.8
205.0	7.0	6.6	6.4	6.6	6.4	6.2	4.6	4.4	4.4	4.4	4.2	3.8
210.0	6.8	6.4	6.4	6.6	6.4	6.2	4.6	4.4	4.4	4.2	4.2	3.8
215.0	6.8	6.4	6.4	6.6	6.4	6.2	4.4	4.4	4.4	4.2	4.0	3.8
220.0	6.6	6.2	6.2	6.4	6.2	6.2	4.4	4.2	4.4	4.2	4.0	3.8
225.0	6.6	6.2	6.2	6.4	6.2	6.2	4.4	4.2	4.4	4.2	4.0	3.8
230.0	6.4	6.2	6.2	6.4	6.0	6.2	4.2	4.2	4.4	4.0	4.0	3.8
235.0	6.4	6.0	6.2	6.2	6.0	6.0	4.2	4.0	4.2	4.0	4.0	3.8
240.0	6.0	6.0	6.0	6.0	6.0	6.0	4.2	4.0	4.2	4.0	3.8	3.8
245.0	5.6	5.8	6.0	6.0	5.8	6.0	4.0	4.0	4.2	4.0	3.8	3.8
250.0	5.2	5.4	6.0	5.8	5.8	6.0	4.0	4.0	4.0	3.8	3.8	3.8
255.0	4.8	5.2	5.6	5.4	5.4	5.8	4.0	4.0	4.0	3.8	3.8	3.8
260.0	4.6	5.0		4.8	4.8	5.6	4.0	3.8	4.0	3.8	3.8	3.8
265.0	4.4	4.6		4.4	4.4	5.0	3.8	3.8	4.0	3.8	3.6	3.8
270.0	4.0	4.4		3.8	3.8		3.6	3.6	3.8	3.6	3.6	3.8
275.0	3.8	4.0		3.2	3.2		3.4	3.6	3.8	3.6	3.6	3.8
280.0	3.6	3.8		2.8	2.8		3.2	3.6		3.0	3.0	3.6
285.0	3.2	3.6		2.4	2.4		3.0	3.4		2.6	2.6	
290.0	3.0	3.2		2.0	2.0		2.8	3.0		2.2	2.2	
295.0	2.8	3.0					2.6	2.8				
300.0	2.6	2.6					2.2	2.6				
305.0	2.2						2.0	2.4				
310.0	1.8											



THIS CHART IS ONLY A GUIDE AND SHOULD NOT BE USED TO OPERATE THE CRANE.

The individual crane's load chart, operating instructions and other instructional plates must be read and understood prior to operating the crane.

# Load chart

## Hydraulic offsettable swingaway with inserts

 74,8 m - 80 m  
(245 ft - 263 ft)
  29 m - 37 m  
(95 ft - 121 ft)
  54 500 kg  
(120,900 lb)
  27 ft 9 in spread  
(100%)
  360°

  Pounds x 1000

Feet	245.3' + 95.1'			262.5' + 95.1'			245.3' + 121.4'			262.5' + 121.4'		
	5°	5°- 20°	20°- 40°	5°	5°- 20°	20°- 40°	5°	5°- 20°	20°- 40°	5°	5°- 20°	20°- 40°
75.0	8.4			7.2								
80.0	8.4			7.2			5.6					
85.0	8.4			7.2			5.6					
90.0	8.4			7.2			5.6					
95.0	8.4	8.4		7.2	7.2		5.6				4.6	
100.0	8.4	8.4		7.2	7.2		5.6	5.6		4.6	4.6	
105.0	8.4	8.4	7.0	7.2	7.2		5.6	5.6		4.6	4.6	
110.0	8.4	8.2	7.0	7.2	7.2		5.6	5.6		4.6	4.6	
115.0	8.4	8.2	7.0	7.2	7.2	6.2	5.6	5.6	4.4	4.6	4.6	
120.0	8.4	8.0	7.0	7.2	7.2	6.2	5.6	5.6	4.4	4.6	4.6	3.8
125.0	8.4	8.0	7.0	7.2	7.2	6.2	5.6	5.6	4.4	4.6	4.6	3.8
130.0	8.4	7.8	7.0	7.2	7.2	6.2	5.6	5.4	4.4	4.6	4.6	3.8
135.0	8.2	7.8	7.0	7.2	7.2	6.2	5.6	5.4	4.4	4.6	4.6	3.8
140.0	8.2	7.6	7.0	7.2	7.2	6.2	5.6	5.4	4.4	4.6	4.6	3.8
145.0	8.0	7.6	7.0	7.2	7.2	6.2	5.4	5.2	4.4	4.6	4.6	3.8
150.0	8.0	7.6	7.0	7.2	7.0	6.2	5.4	5.2	4.4	4.6	4.6	3.8
155.0	7.8	7.4	7.0	7.2	7.0	6.2	5.4	5.0	4.4	4.6	4.6	3.8
160.0	7.8	7.4	7.0	7.2	7.0	6.2	5.2	5.0	4.4	4.6	4.6	3.8
165.0	7.4	7.2	7.0	7.2	6.8	6.2	5.2	5.0	4.4	4.6	4.6	3.8
170.0	7.4	7.0	6.8	7.0	6.8	6.2	5.0	4.8	4.4	4.6	4.6	3.8
175.0	7.4	7.0	6.8	6.2	6.2	6.2	5.0	4.8	4.4	4.6	4.4	3.8
180.0	7.2	6.8	6.6	5.4	5.4	6.2	5.0	4.8	4.4	4.6	4.4	3.8
185.0	6.6	6.6	6.6	4.8	4.8	6.0	4.8	4.6	4.4	4.6	4.4	3.8
190.0	6.0	6.0	6.6	4.0	4.0	5.2	4.6	4.4	4.4	4.0	4.0	3.8
195.0	5.2	5.2	6.4	3.4	3.4	4.6	4.6	4.4	4.4	3.4	3.4	3.8
200.0	4.6	4.6	5.8	2.8	2.8	4.0	4.6	4.4	3.6	2.8	2.8	3.8
205.0	4.0	4.0	5.0	2.2		3.2	4.0	4.0	3.0	2.2	2.2	3.4
210.0	3.4	3.4	4.4			2.6	3.4	3.4	2.4			2.6
215.0	2.6	2.6	3.8			2.0	2.8	2.8				2.2
220.0	2.0	2.0	3.0				2.4	2.4				
225.0			2.4									
230.0			1.8									

THIS CHART IS ONLY A GUIDE AND SHOULD NOT BE USED TO OPERATE THE CRANE.

Grove GMK6300L The individual crane's load chart, operating instructions and other instructional plates must be read and understood prior to operating the crane.



# Load chart

## Heavy duty jib

### Fixed angle



15,6 m-80 m  
(51 ft-263 ft)



2 m  
(6.6 ft)



92 500 kg  
(203,900 lb)



27 ft 9 in ft spread  
(100%)



360°



Pounds (thousands)

Feet	51.1' + 6.6'		85.8' + 6.6'		120.6' + 6.6'		155.9' + 6.6'		191.6' + 6.6'		227.4' + 6.6'		262.5' + 6.6'	
	8°	30°	8°	30°	8°	30°	8°	30°	8°	30°	8°	30°	8°	30°
10.0		84.0												
15.0		84.0		84.0										
20.0		84.0		84.0		84.0								
25.0		84.0		84.0		84.0								
30.0		84.0		84.0		84.0		84.0						
35.0	84.0	84.0		84.0		84.0		84.0		52.0				
40.0	84.0	84.0		84.0		84.0		84.0		52.0		31.4		
45.0	84.0			84.0		84.0		80.0		52.0		31.4		
50.0				84.0		84.0		76.0		52.0		31.4		20.6
55.0				84.0		84.0		73.0		52.0		31.4		20.6
60.0			84.0	84.0		84.0		70.0		52.0		31.4		20.6
65.0			84.0	84.0		84.0		67.0		52.0		31.4		20.6
70.0			77.0	77.0		73.0		64.0		52.0		31.4		20.6
75.0			68.0			68.0		61.0		50.0		31.4		20.6
80.0					64.0	63.0		59.0		47.0		31.4		20.6
85.0					59.0	60.0		57.0		43.4		31.4		20.6
90.0					55.0	55.0		55.0		40.0		31.4		20.6
95.0					51.0	51.0		51.0		37.2		31.4		20.6
100.0					47.0			47.0		34.6		31.4		20.6
105.0					43.4		43.4	43.8		32.2		30.4		20.6
110.0					37.6		40.2	40.8		30.2		28.8		20.6
115.0							37.4	37.8		28.2		27.0		20.6
120.0							35.0	35.4		26.4		25.2		20.6
125.0							32.4	32.8		24.8		23.0		20.6
130.0							30.0	30.2		23.0		20.8		20.6
135.0							27.8		22.8	21.4		19.2		19.6
140.0							25.6		21.8	20.4		18.2		18.4
145.0									20.6	19.8		17.4		17.6
150.0									19.4	19.2		16.6		16.8
155.0									18.8	18.6		16.0		15.8
160.0									18.2			15.2		15.0
165.0									17.6			14.6		14.2
170.0									17.0			14.0		13.2
175.0									16.6			13.4		12.4
180.0												13.0		11.6
185.0												12.4		11.0
190.0												12.0		10.2
195.0														9.6
200.0														9.0
205.0														8.2
210.0														7.6
215.0														7.0
220.0														6.4

THIS CHART IS ONLY A GUIDE AND SHOULD NOT BE USED TO OPERATE THE CRANE.

Grove GMK6300L The individual crane's load chart, operating instructions and other instructional plates must be read and understood prior to operating the crane.



# Load chart

## Heavy duty jib

### Fixed angle



15,6 m-80 m  
(51 ft-263 ft)



2 m  
(6.6 ft)



54 500 kg  
(120,100 lb)



27 ft 9 in spread  
(100%)



360°



Pounds (thousands)

Feet	51.1' + 6.6'		85.8' + 6.6'		120.6' + 6.6'		155.9' + 6.6'		191.6' + 6.6'		227.4' + 6.6'		262.5' + 6.6'	
	8°	30°	8°	30°	8°	30°	8°	30°	8°	30°	8°	30°	8°	30°
10.0		84.0												
15.0		84.0		84.0										
20.0		84.0		84.0		84.0								
25.0		84.0		84.0		84.0								
30.0		84.0		84.0		84.0		84.0						
35.0	84.0	84.0		84.0		84.0		84.0		52.0				
40.0	84.0	84.0		84.0		84.0		84.0		52.0		31.4		
45.0	84.0			84.0		84.0		80.0		52.0		31.4		
50.0				84.0		84.0		76.0		52.0		31.4		20.6
55.0				82.0		77.0		72.0		52.0		31.4		20.6
60.0			70.0	71.0		68.0		64.0		52.0		31.4		20.6
65.0			63.0	62.0		61.0		57.0		50.0		31.4		20.6
70.0			57.0	58.0		55.0		51.0		44.0		31.4		20.6
75.0			50.0			49.0		46.0		39.6		31.4		20.6
80.0					48.0	47.0		41.4		35.6		31.4		20.6
85.0					42.8	43.4		37.4		33.8		30.8		20.6
90.0					38.6	39.2		34.0		32.2		29.2		20.6
95.0					34.8	35.4		31.6		30.8		28.0		20.6
100.0					31.6			30.4		29.4		27.0		20.6
105.0					28.6		28.8	29.2		27.0		25.6		20.6
110.0					26.2		26.2	26.8		24.8		23.6		19.2
115.0							23.8	24.4		22.8		21.6		17.4
120.0							21.8	22.2		20.6		19.8		15.6
125.0							19.8	20.2		18.6		18.6		14.0
130.0							18.6	18.4		16.8		17.0		12.6
135.0							17.8		16.6	16.0		15.6		11.2
140.0							17.2		15.8	15.0		14.2		10.0
145.0									14.6	14.4		12.8		8.8
150.0									13.2	13.6		11.4		7.6
155.0									12.0	12.8		10.2		6.6
160.0									11.0			9.0		5.6
165.0									10.0			8.0		4.6
170.0									9.0			7.0		3.6
175.0									8.2			6.0		
180.0												5.2		
185.0												4.4		
190.0												3.6		
195.0														
200.0														
205.0														
210.0														
215.0														
220.0														

# Symbols glossary



Axles



Counterweight



Grade



Gear



Boom



Drive



Heavy duty jib



Radius



Boom elevation



Electrical system



Hoist



Rotation



Boom extension



Engine



Hookblock



Speed



Boom length



Extension



Hydraulic system



Steering



Boom nose



Frame



Lights



Suspension



Brakes



Fuel tank capacity



Oil



Swing



Cab



Outriggers



Outrigger controls



Tires



Transmission

# Notes



## Manitowoc Cranes

### Regional headquarters

#### Americas

**Manitowoc, Wisconsin, USA**

Tel: +1 920 684 6621

Fax: +1 920 683 6277

**Shady Grove, Pennsylvania, USA**

Tel: +1 717 597 8121

Fax: +1 717 597 4062

#### Europe, Middle East, Africa

**Dardilly, France**

Tel: +33 (0)4 72 18 20 20

Fax: +33 (0)4 72 18 20 00

#### China

**Shanghai, China**

Tel: +86 21 6457 0066

Fax: +86 21 6457 4955

#### Greater Asia-Pacific

**Singapore**

Tel: +65 6264 1188

Fax: +65 6862 4040

### Regional offices

#### Americas

**Brazil**

Alphaville

**Mexico**

Monterrey

**Chile**

Santiago

#### Europe, Middle East, Africa

**France**

Baudemont

Cergy

Decines

**Germany**

Langenfeld

**Italy**

Lainate

**Netherlands**

Breda

**Poland**

Warsaw

**Portugal**

Baltar

**Russia**

Moscow

**South Africa**

Johannesburg

**U.A.E.**

Dubai

**U.K.**

Buckingham

#### China

Beijing

Chengdu

Guangzhou

Xian

#### Greater Asia-Pacific

**Australia**

Brisbane

Melbourne

Sydney

**India**

Chennai

Delhi

Hyderabad

Pune

**Korea**

Seoul

**Philippines**

Makati City

**Singapore**

### Factories

**Brazil**

Passo Fundo

**China**

TaiAn

Zhangjiagang

**France**

Charlieu

Moulins

**Germany**

Wilhelmshaven

**India**

Pune

**Italy**

Niella Tanaro

**Portugal**

Baltar

Fânzeres

**USA**

Manitowoc

Port Washington

Shady Grove

This document is non-contractual. Constant improvement and engineering progress make it necessary that we reserve the right to make specification, equipment, and price changes without notice. Illustrations shown may include optional equipment and accessories and may not include all standard equipment.